



freshlook
engineering and products ltd

PART OF THE
ETF
ENGINEERING GROUP





Machined Parts



CNC Turning & Milling

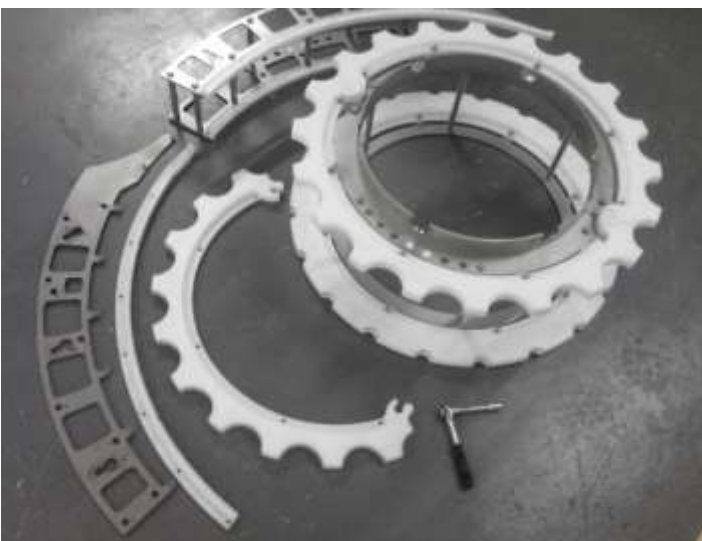

**Bottling Star Wheel
Laser Profiling**

**Fabrications
Structural Works**



Spiral Staircase

Apex



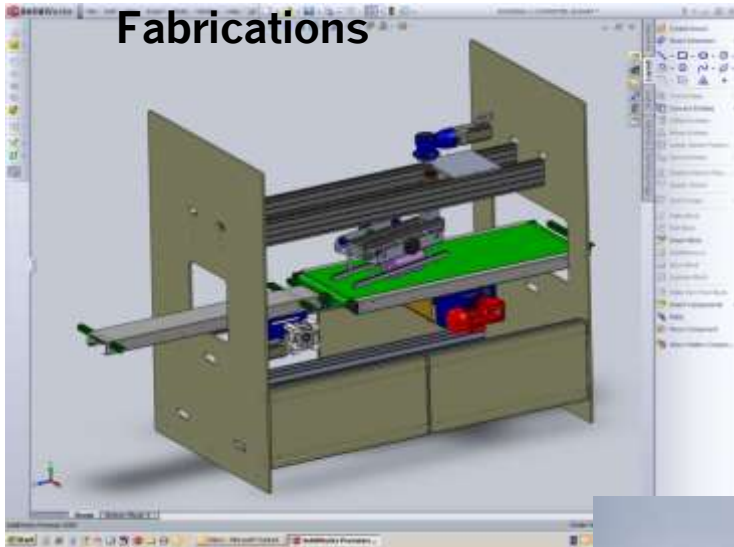

**2D & 3D Cad
Exploded Views**

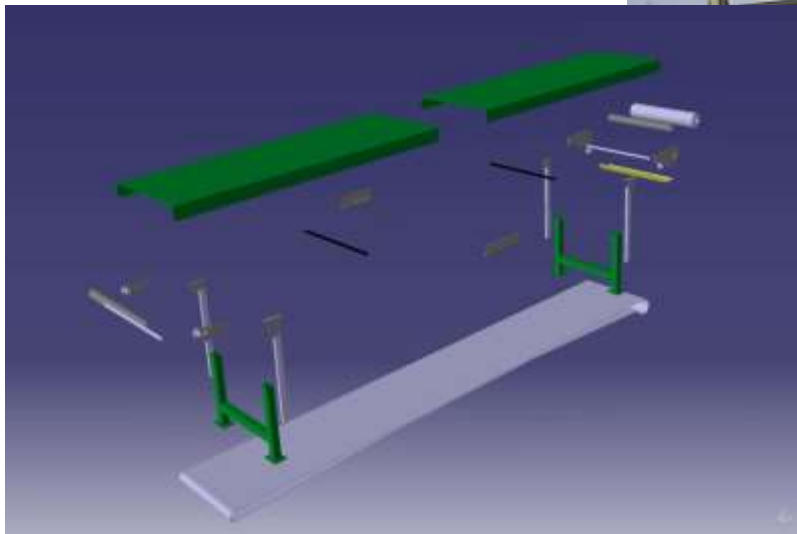
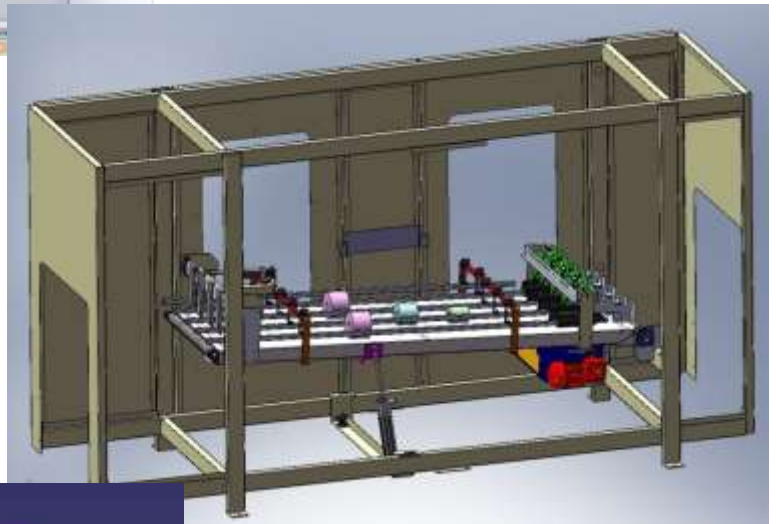



Stainless Steel Stairs and Walkways



Stainless Merging Conveyor



Easy Tracking Belts





**Aluminium Modular
Conveyors**

**Aluminium
Elevating Conveyor**





**Shopping Trolley
Deburring Unit**





Easy Clean Flighted Conveyor



**Stainless Steel Easy
Clean Conveyors**



Stainless Steel Roller and Belted Conveyors





Spare Parts Trolley



Stainless Steel Belt Curve Conveyor



Stainless Steel Belt Straight (Knife Edge)



Slat Curve & Belted Straight



Stainless Steel Matting Link Chain Conveyor



Stainless Steel Matting Link Chain Conveyor



Stainless Steel Matting Link Chain Conveyor

Straight, Curves, Multi-lane





Panels to Customers Specifications

Allen Bradley
Siemens
Mitsubishi
Pilz





**Case Conveyors,
Diverters**





Transporting and Moving



Machine relocation and Installations

Innovation

- Complete machine moved “as one”
- Saves time
- Saves money



Design to Manufacture

- 3D Cad
- AutoCAD
- Mechanical Build
- Installation

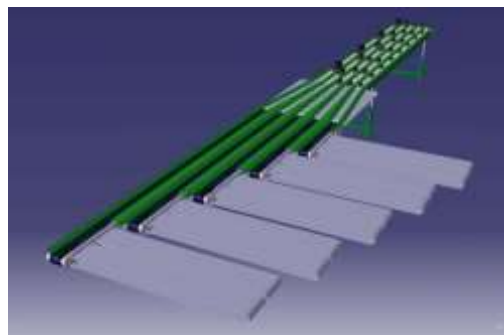

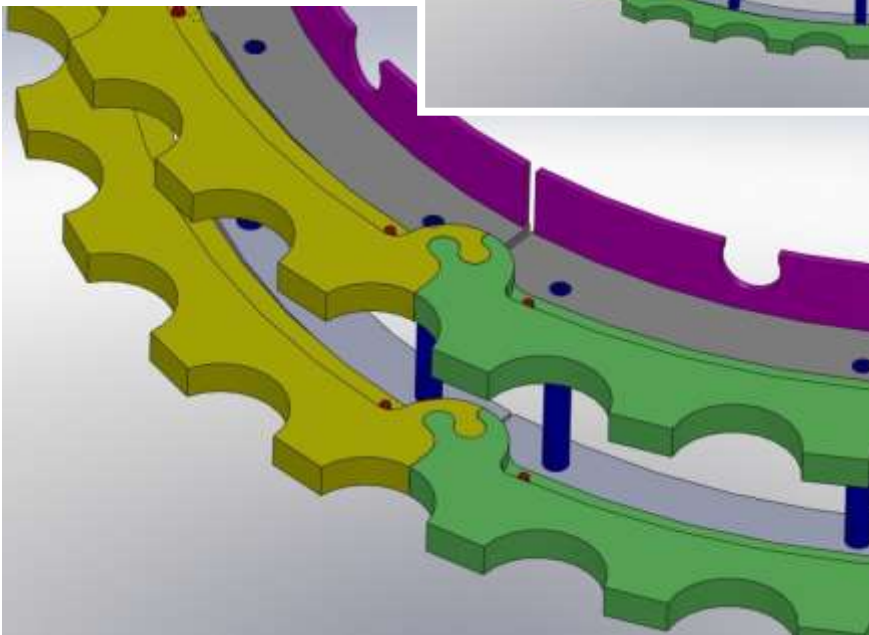
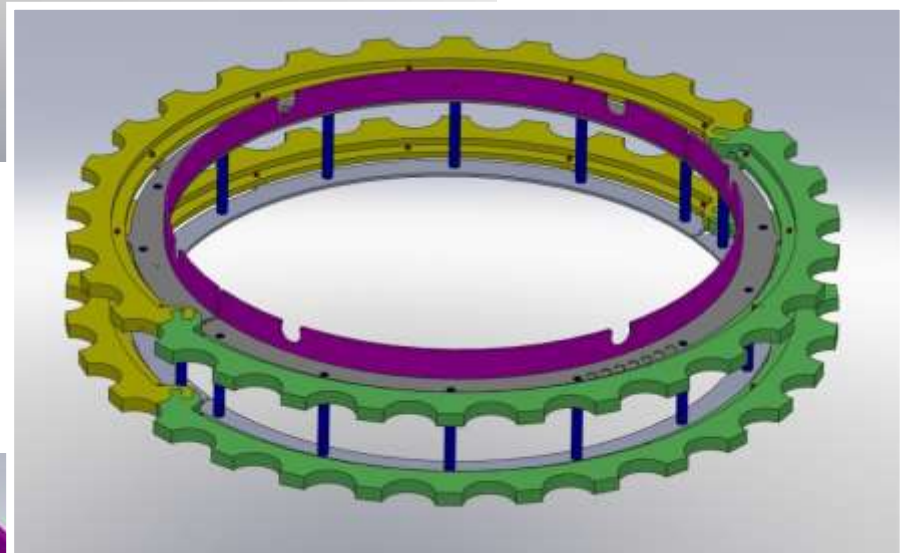
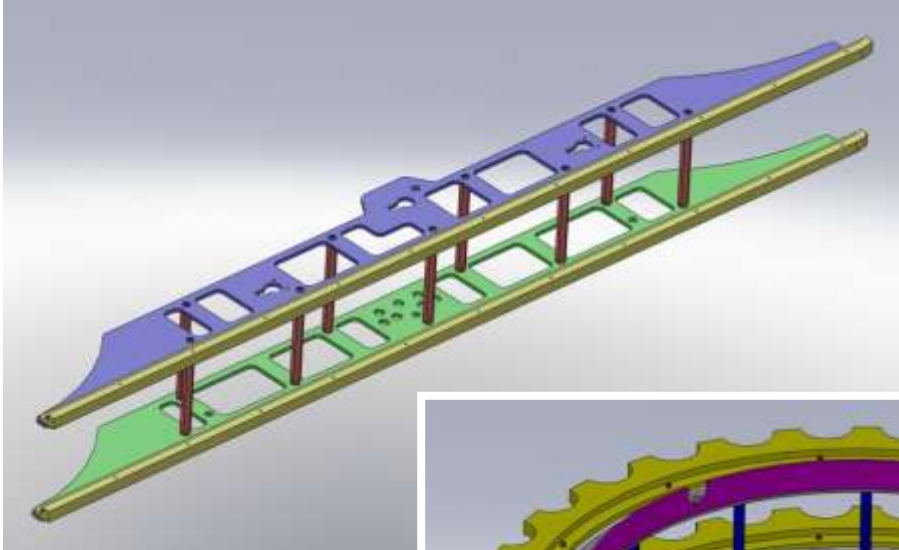







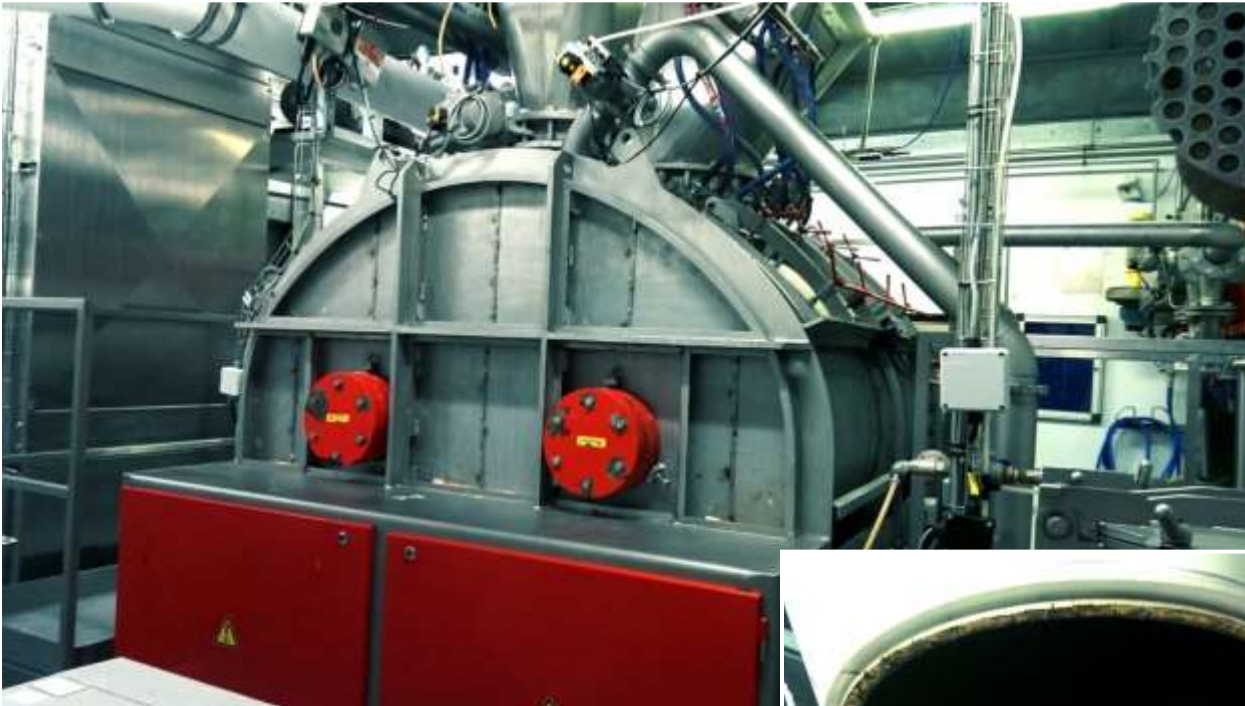







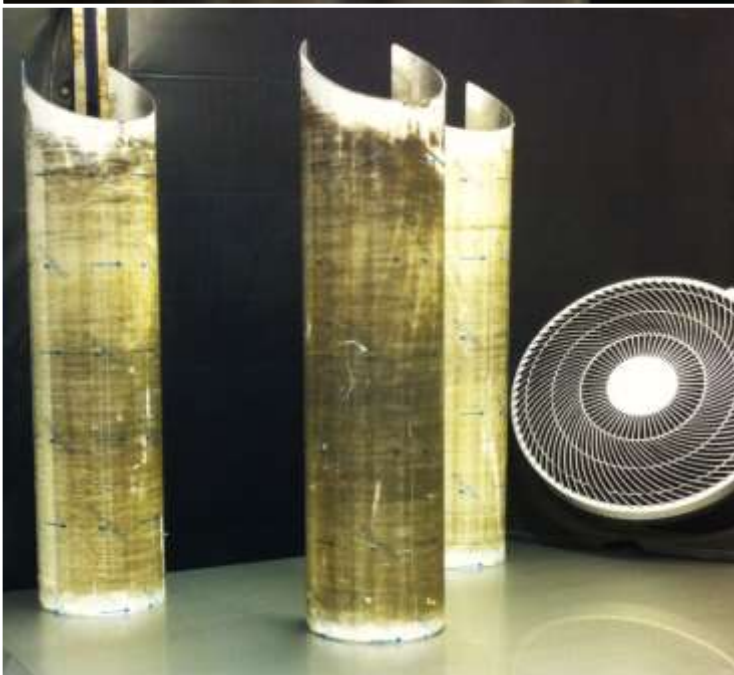



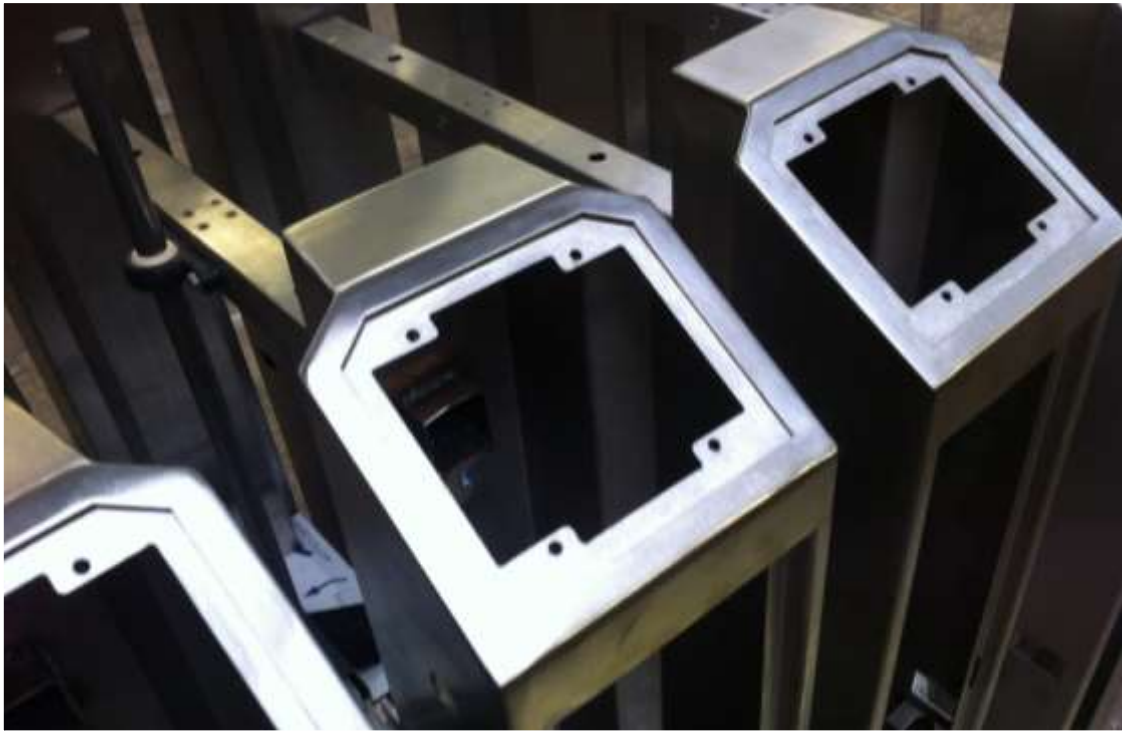



An overview of the group

The Etavoni business was founded by a group of mechanical and systems engineers with a combined experience of over 50 years in engineering services and production machinery. Identified was a gap in the market for a company with the expertise and flexibility to offer its involvement in projects ranging from basic machinery servicing or full system design and build.

Since the company was founded in 2004, it has expanded to cover dozens of industry sectors. The range of products and services offered has broadened, to include every common conveyor style, various handling machines, together with design and breakdown services.

Since the foundation of Truarc in 2007, they have offered complete CNC metal work from design to production, to final assembly and finishing. Truarc strive to set the best standards within sheet metal fabrication and now with even more dedicated designers, fabricators and the latest RADAN software, there are endless possibilities they can achieve for you. Excellent quality jobs that prove functional and affordable will exceed your expectations.

Established in 1989, Freshlook has a strong base of customers both in and out of the local area of Somerset, they are committed to providing high customer satisfaction as a top priority. As one of the pioneers of sub-contract laser cutting, they have been at the forefront of the UK laser cutting industry. With the latest fabrication facilities along with CNC, profiling and folding, Freshlook are able to manufacture to an exceptional finish.

In 2010 we were then strengthened with the formation of the ETF Engineering Group. Etavoni, Truarc and Freshlook can be your partners in production!

ETF-Group.co.uk

Etavoni.com

Truarc.com

Freshlookengineering.com

Conveyors, Software, Mechanical & Electrical Design, Systems & Control,
Project Management, Electrical Panels, Equipment Relocation, Machines
Food / Beverage / Tissue Industries
Conveyors, Software, Mechanical & Electrical Design, Systems & Control,
Project Management, Electrical Panels, Equipment Relocation, Machines
Project and Consultancy Management
Conveyors, Software, Mechanical & Electrical Design, Systems & Control,
Project Management, Electrical Panels, Equipment Relocation, Machines
Conveyor Systems / Stainless Steel / Powder Coated
Conveyors, Software, Mechanical & Electrical Design, Systems & Control,
Project Management, Electrical Panels, Equipment Relocation, Machines
Solutions and Manufacture / Palletisation Machines
Conveyors, Software, Mechanical & Electrical Design, Systems & Control,
Project Management, Electrical Panels, Equipment Relocation, Machines
Design and Development / 2D & 3D Cad
Conveyors, Software, Mechanical & Electrical Design, Systems & Control,
Project Management, Electrical Panels, Equipment Relocation, Machines
Production Line Analysis / Product Flow Optimisation
Conveyors, Software, Mechanical & Electrical Design, Systems & Control,
Project Management, Electrical Panels, Equipment Relocation, Machines
Machine Removal / Relocation / Installations
Conveyors, Software, Mechanical & Electrical Design, Systems & Control,
Project Management, Electrical Panels, Equipment Relocation, Machines
Full Manufacturing – CNC Machinery
Conveyors, Software, Mechanical & Electrical Design, Systems & Control,
Project Management, Electrical Panels, Equipment Relocation, Machines
Stainless Steel Components / Fabrications
Conveyors, Software, Mechanical & Electrical Design, Systems & Control,
Project Management, Electrical Panels, Equipment Relocation, Machines
Spare Parts / Drawn & Manufactured / Laser cutting
Conveyors, Software, Mechanical & Electrical Design, Systems & Control,
Project Management, Electrical Panels, Equipment Relocation, Machines
Shop fitting / MIG/TIG Welding / Fabrication
Conveyors, Software, Mechanical & Electrical Design, Systems & Control,
Project Management, Electrical Panels, Equipment Relocation, Machines
Machine Installations and Commissioning
Conveyors, Software, Mechanical & Electrical Design, Systems & Control,
Project Management, Electrical Panels, Equipment Relocation, Machines
Software – Allen Bradley / Siemens / All Others
Conveyors, Software, Mechanical & Electrical Design, Systems & Control,
Project Management, Electrical Panels, Equipment Relocation, Machines
Conveyors, Software, Mechanical & Electrical Design, Systems & Control,
Project Management, Electrical Panels, Equipment Relocation, Machines
Conveyors, Software, Mechanical & Electrical Design, Systems & Control,
Project Management, Electrical Panels, Equipment Relocation, Machines
Conveyors, Software, Mechanical & Electrical Design, Systems & Control,
Project Management, Electrical Panels, Equipment Relocation, Machines



The ETF Engineering Group
Unit A
Wellsway Works
Wells Road
Radstock
BA3 3RZ

Tel: + 44 (0) 1761 420 774
Fax: + 44 (0) 1761 434 459
E mail: ask@etavoni.com
sales@truarc.co.uk
laser@freshlook.co.uk